

San Ace 120 GV type

DC Fans 120mm

Features

Large air flow and high static pressure

- Maximum air flow : increased by approx. 31%
- Maximum static pressure : increased by approx. 87% compared with our conventional product*.

Energy-saving design

- Power consumption : reduced by approx. 12% with airflow performance that is identical to our conventional product*.

* Our conventional product is the DC cooling fan :
120×120×25 mm thick fan "San Ace 120" G type (9G1212G401)



120 × 120 × 25mm

Specifications

Model No.	Rated Voltage (V)	Operating Voltage Range (V)	PWM Duty Cycle ^① (%)	Rated Current (A)	Rated Input (W)	Rated Speed (min ⁻¹)	Air Flow (m ³ /min) (CFM)		Static Pressure (Pa) (inchH ₂ O)		SPL (dB [A])	Operating Temperature Range (°C)	Life Expectancy (h)
9GV1212P4G01 (011)	12	10.2 to 13.8	100	1.68	20.16	5,100	4.83	171	224	0.90	58	-10 to +70	40,000
			0	0.18	2.16	1,650	1.56	55.1	23.5	0.09	30		
9GV1248P4G01 (011)	48	40.8 to 60.0	100	0.42	20.16	5,100	4.83	171	224	0.90	58		
			0	0.07	3.36	1,650	1.56	55.1	23.5	0.09	30		
9GV1248P4H01 (011)			100	0.33	15.84	4,600	4.35	154	182	0.73	55		
			0	0.07	3.36	1,650	1.56	55.1	23.5	0.09	30		

The numbers in () represent ribless models.

※PWM Frequency : 25kHz

Common Specifications

- Material Frame: Plastics (Flammability: UL94V-0) , Impeller: Plastics (Flammability: UL94V-1)
- Life Expectancy Varies for each model
(L10: Survival rate: 90% at 60°C, rated voltage, and continuously run in a free air state)
- Motor Protection System Current blocking function and Reverse polarity protection
- Dielectric Strength 50/60 Hz, 500VAC, 1 minute (between lead conductor and frame)
- Sound Pressure Level (SPL) Expressed as the value at 1m from air inlet side
- Operating Temperature Range Varies for each model (Non-condensing)
- Lead Wire ⊕red ⊖black Sensor: yellow Control: brown
- Mass 260g

120mm

San Ace 120 GV type

Air Flow and Static Pressure Characteristics

- PWM Duty Cycle

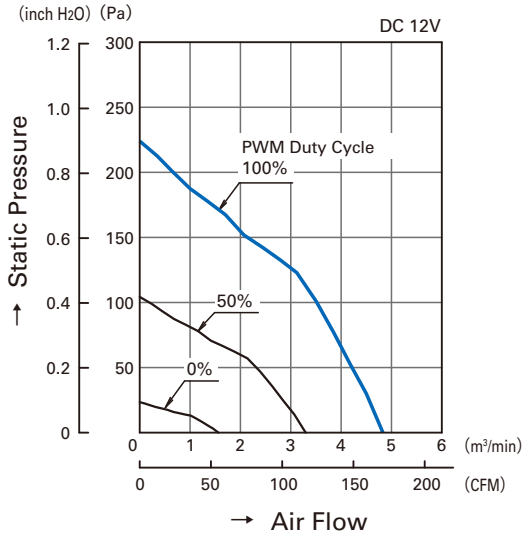

9GV1212P4G01 (011)

- Operating Voltage Range

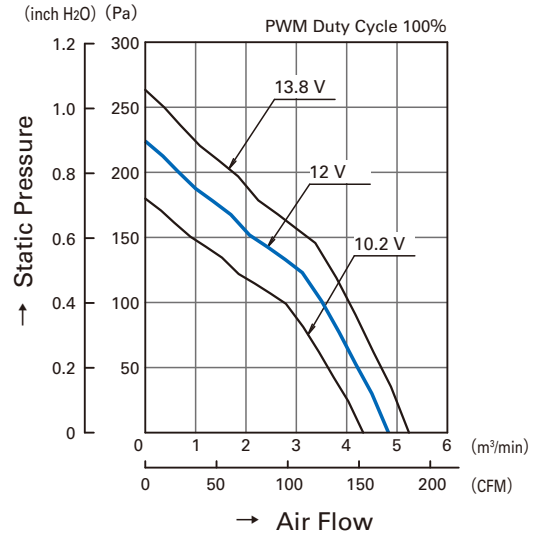

9GV1212P4G01 (011)

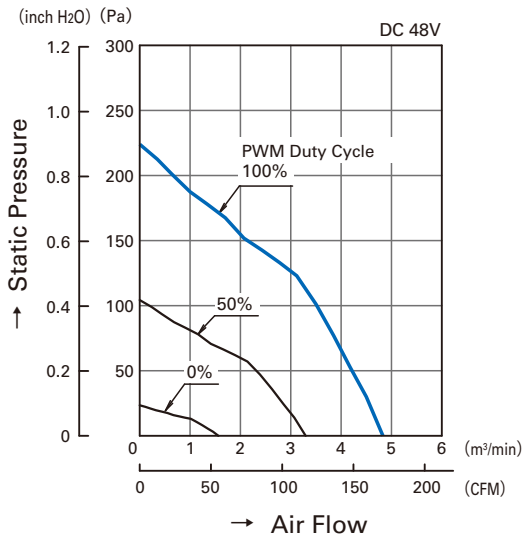

9GV1248P4G01 (011)

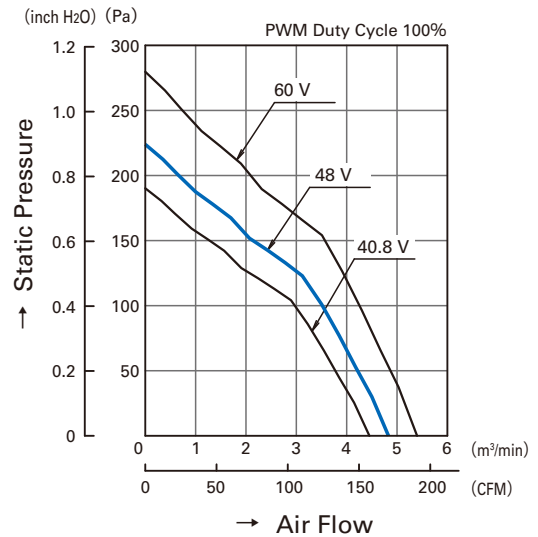

9GV1248P4G01 (011)

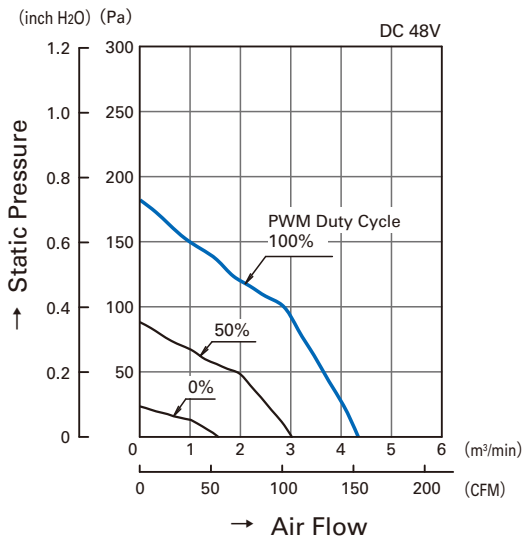

9GV1248P4H01 (011)

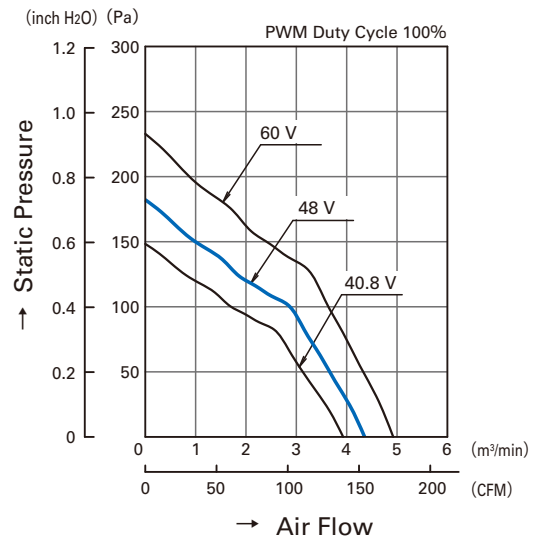

9GV1248P4H01 (011)

PWM Duty - Speed Characteristics Example

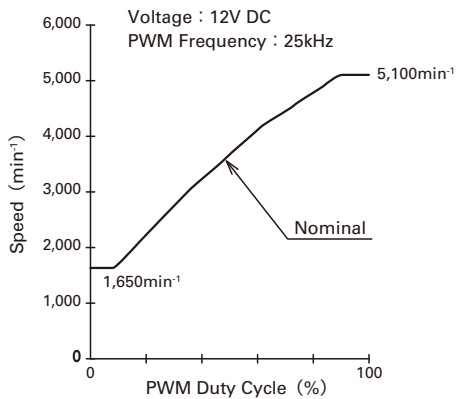

9GV1212P4G01 (011)

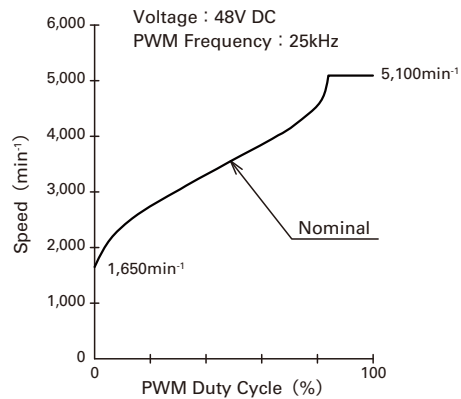

9GV1248P4G01 (011)

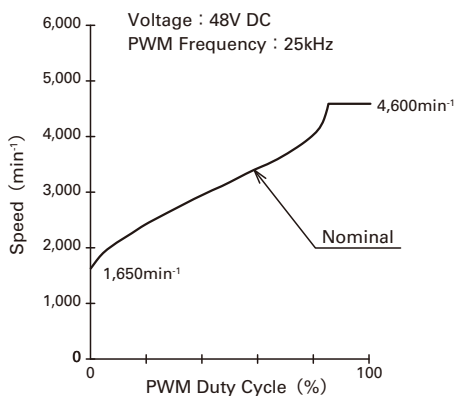

9GV1248P4H01 (011)

PWM Input Signal Example

Input Signal Wave Form

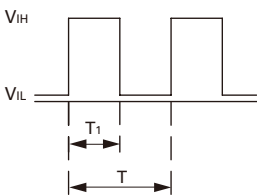

$V_{IH}=4.75V$ to $5.25V$

$V_{IL}=0V$ to $0.4V$

$$\text{PWM Duty Cycle (\%)} = \frac{T_1}{T} \times 100$$

$$\text{PWM Frequency } 25 \text{ (kHz)} = \frac{1}{T}$$

Source Current (I_{source}) : $1mA$ Max. at control voltage $0V$

Sink Current (I_{sink}) : $1mA$ Max. at control voltage $5.25V$

Control Terminal Voltage : $5.25V$ Max. (Rated voltage $12V$ fan)
 $8.0V$ Max. (Rated voltage $48V$ fan)
 (Open Circuit)

When the control lead wire is no connecting, the speed is the same speed as at 100% of PWM cycle.

This fan speed should be controlled by PWM input signal of either TTL input or open collector, drain input.

Connection Schematic

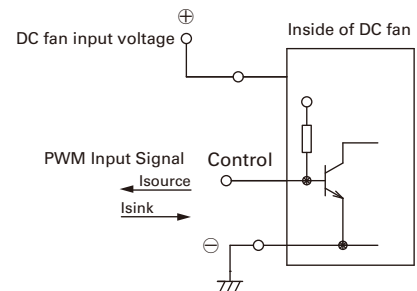

Specifications for Pulse Sensors

Output circuit : Open collector

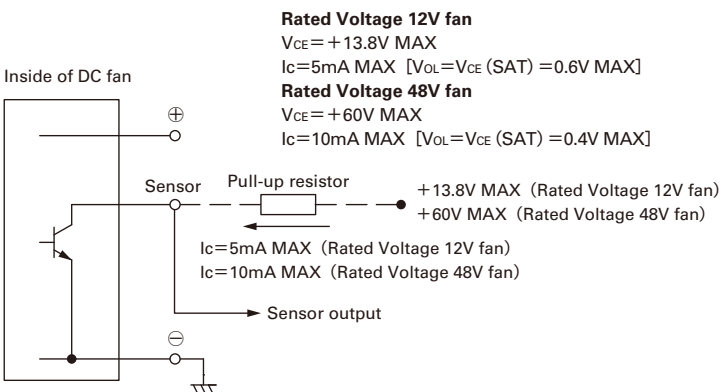

Output waveform (Need pull-up resistor)

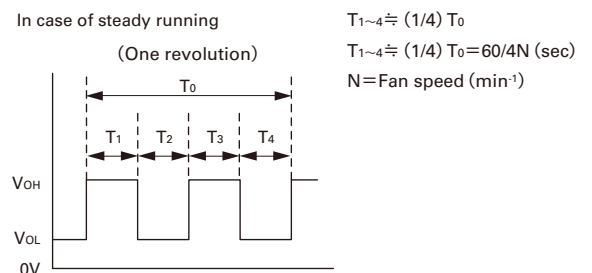

Dimensions (unit : mm)

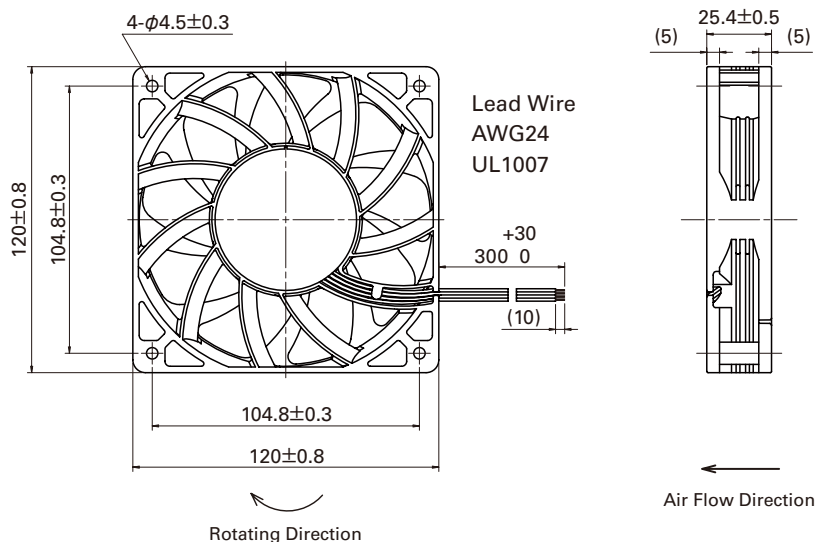

Reference dimension of mounting holes and vent opening (unit : mm)

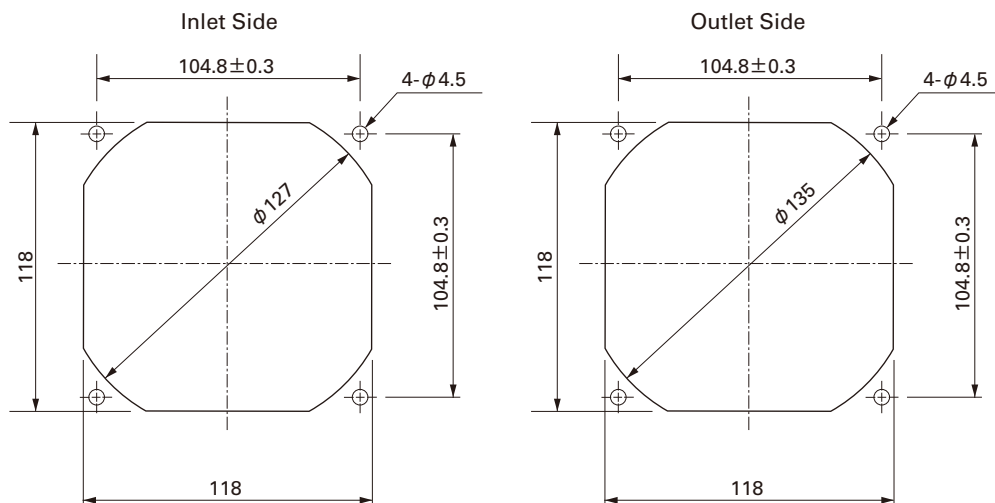

Notice

- The products shown in the catalog are subject to Japanese Export Control Law. Diversion contrary to the law of exporting country is prohibited.
- To protect against electrolytic corrosion that may occur in locations with strong electromagnetic noise, we provide fans that are unaffected by electrolytic corrosion.